



# THE HS BUILDING KIT

Instructions for a do-it-yourself assembly

# Simple – proof – low cost Self-assembly of the HS-building kit

The basic component of the HS-Unit System is the galvanized steel frame, which consists of several steel supports, formed as C-profiles and available in various dimensions: 100 - 200 mm (width) x 50/70 mm (depth) x 3 mm (material thickness), according to requirement. The connection between the steel supports

(support profiles) and the pallet bearers (bearer profiles is made by means of the Snap-In connection. The steel supports are joined at the correct width spacing by means of the frame binder. After erection, a roof construction can be assembled on the upper frame binder resp. braced frame U 100, if required.

## Chamber Construction System for variable storage space

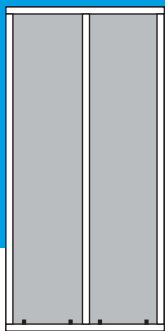

Two chamber combination

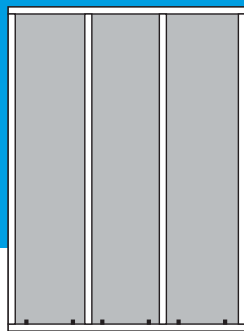

Three chamber combination

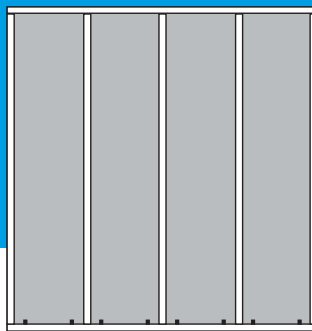

Four chamber combination

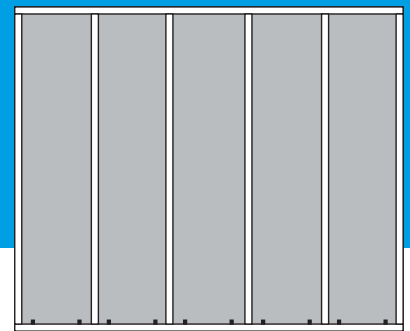

Five chamber combination

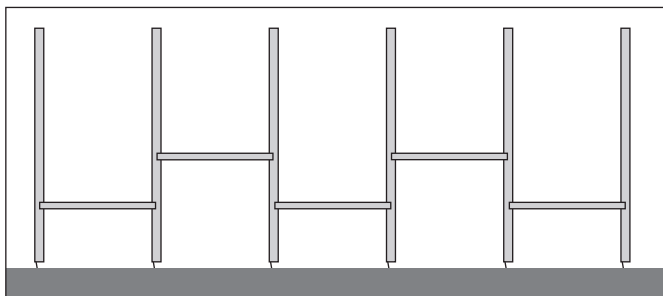

Erection with assembly aids

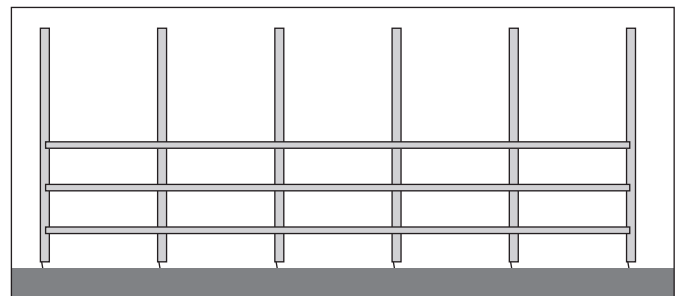

Fitted pallet bearers (bearer profiles)

The length of the curing chambers is divided into structural groups. Every group consists of several galvanized steel frames, each of which is an individual absolutely sturdy unit for itself and statically steadfast on its own. Installation aids are supplied for erection of the structural groups. These are short pallet bearers which are exactly as long as the screen measure.

After the concrete slab has been checked and the necessary axis (centre transfer car, front of chamber as well as at least one chamber aisle - centre) have been determined acc. to drawing and marked, the steel columns of one frame are placed on the ground. The clamps of the Snap-in connection are to the inside. The closed sides of the C-profile are in direction of the chamber entrance. In order to ensure an installation of the stiffening profiles without problems, care should be taken to the installation direction (acc. to drawing) and the sub positions of the frame elements. Now, the

plugs of the lower and upper frame connectors are hammered into the Cprofiles with a plastic hammer. Then, the first frame can be erected and temporarily put into place using support profiles.

Now, the second frame is premounted on the floor, erected and connected with the first one by means of the installation aids. This way, as many frames are erected one after the other until the structural group is completely installed. The amount of frames necessary for one structural unit varies depending on the project and is subject to the pallet bearers which connect all frames of each structural unit.

The pallet bearer for the first stories (up to approx. 2 metres in height) can now be installed. This is easily done by means of snap-in connection using pressure or a plastic hammer. Care must be taken that each connection snaps in.

After lateral correction the group must be levelled. Levelling is done by turning the bolts in the lower frame up to the necessary level, after underlaying with metal strips (in the inside frame columns one adjusting bolt is located on the left side and one on the right side, in the outside columns there is only one adjusting bolt). Then, the still missing pallet bearers are inserted into the structural group. For providing the upper stories with pallet bearers, boards are distributed on the last already installed pallet bearers in order to ensure safe working. While inserting the pallet bearers, the installation aids are taken out and used for the next structural group.

After the first group has been checked for vertical stand of the columns, group by group are installed until the entire chamber system is complete.

The individual groups are bolted to the steel columns as well as to the braced frame U 100. The braced frame U 100 provides the entire structure with additional self-stability and steadfastness.

Now, further stiffening angles are fastened in the side walls and rear wall. Cross bracings are fastened in the roof level. The support profiles can now be removed. Neither fastening of the building wall nor stabilising supports are necessary. The installation of the rails in the chambers is performed by welding to the fasteners in the lower frame binder. Upon request we also offer an installation method by means clamping plates. However, this must be clarified beforehand.

After rail installation, again, a fine levelling should take place. Then, the entire chamber system can be filled with concrete acc. to drawing.

## Erection System

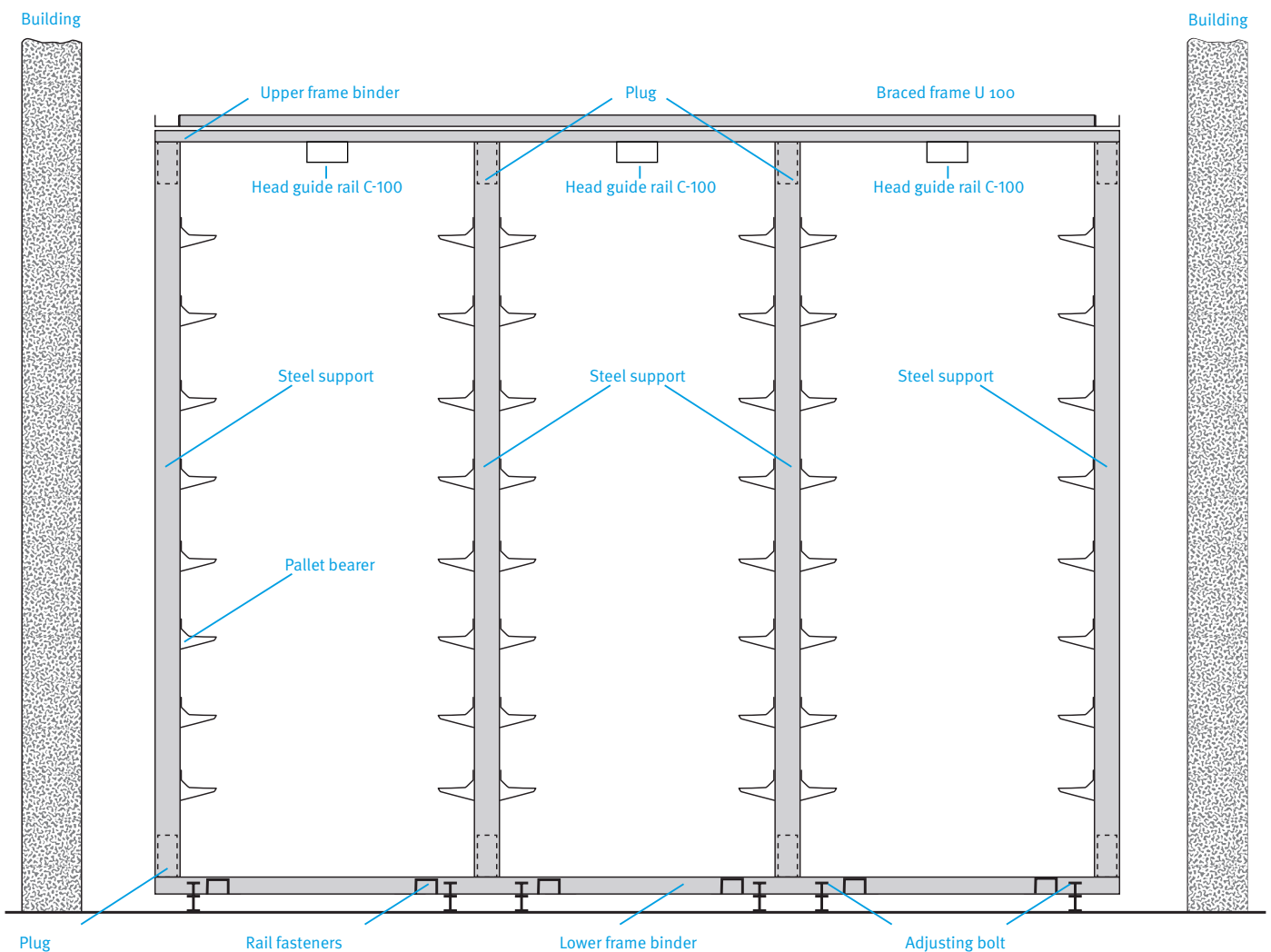

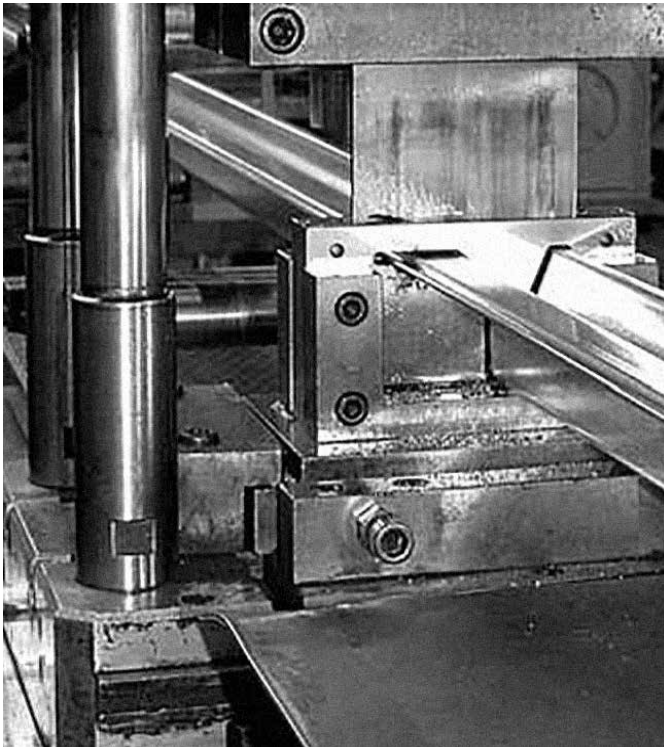

From the steel sheet coil to the finished profile. Highly modern production systems form the HS-profile – here a snap-in pallet bearer.



The result is exactly level and height true installation.

Stable clamps are pressed storey distance apart, for hanging up the pallet bearers. The conical form avoids destructive movements of the pallet bearers during loading and unloading of the chambers. The upper part of the clamp (suspension) is beaded for prevention of bending down, even under higher loading. Above the cramps a peg is pressed in. This holds the pallet bearer (bearer profile) in place.

The pallet bearers are made of hot dip galvanized steel strip, cold rolled to match HS special profile. They have a very high bearing capacity and the 80 mm width offers a good supporting surface with alignment of the pallets.

The pallet bearers are slotted according to the screen measurements. They grip into the two clamps of the steel support (snap-in connection), effecting a stable connection. The numerous connections, resulting from the number of stories, provide the total structure with an extremely high rigidity.

The pallet bearers (bearer profiles) are made in lengths up to 9 meters. In total they make up the length of the entire construction group. The lateral pallet guide prevents the loaded boards from hitting the steel supports (support profiles). Loading and unloading can be carried out fully automatically with great precision due to the wide support with centering slant.

- Easy and safe installation thanks to precisely matched system elements
- Convincing construction in every detail

**HS Anlagentechnik – technology with profile, technology for professionals**

# The HS building kit – Capacity and planning made to measure

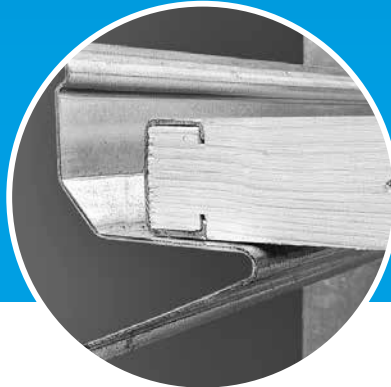
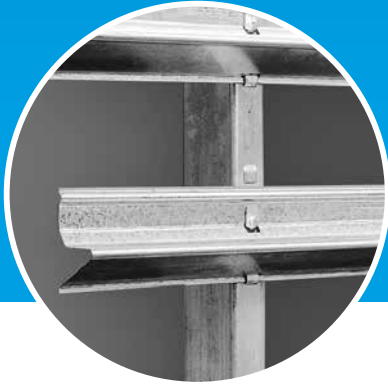

## The TÜV has recognised that too!

The load capacity of the pallet supports with snap-in connection has been tested by the TÜV. The test report confirms that the required load capacity of the support profile is safely ensured.



## Detailed view of single components

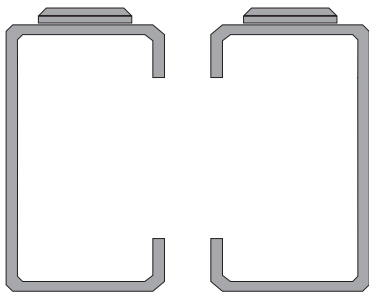

Left and right support profile (steel support)

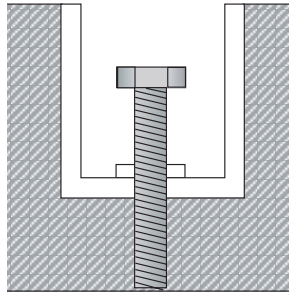

Adjusting bolt

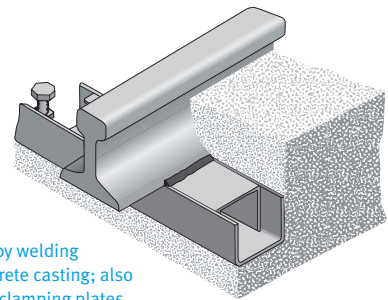

Rail installation by welding followed by concrete casting; also installation with clamping plates is possible



Curing chambers with roller shutters is possible anytime.

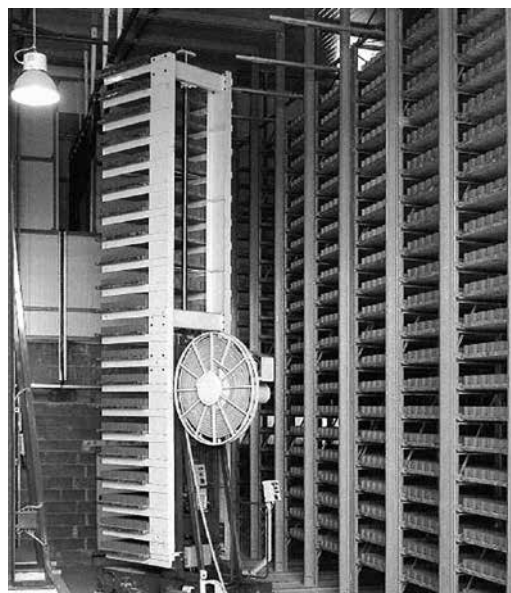

Safe in- and output by means of the finger car and the HS-guiding-rails.



The result is exactly level and height true installation.

# Important notice – please observe

HS curing chamber systems offer highest production security possible, acquired during decades of experience and constant improvements. Only first quality steels are used. These are checked on a regular basis before profiling.

For proper operation and in order to ensure a long operation life of the curing chambers, following must be observed:

- Pallets must always be placed in the center.
- Pallet bearer (bearing profiles) must be free of concrete residues.
- Drive rails shall be free of residues in order to avoid unnecessary swaying and sudden stops of the finger car.
- Pallets shall not be chamfered on the sides to an extent that they become smaller than the indicated pallet size. They must be sufficiently thick in order to avoid bending also when heavy elements are manufactured.
- The setting down speed of the finger car must be adapted to the weight of each product being handled.
- Unorderly drive operation may lead to products sliding or falling over. Special attention is required.
- Pallets must come out of the elevator level in order to avoid a collision when driving into the chambers.
- After failures in the input and output process, the steel columns and snapin connections must be controlled; defects must be repaired.
- The determined pallet loads (pallet plus product) shall not be exceeded.
- The atmosphere in the chambers must be kept in a PH-neutral range.
- In case of constant especially high humidity (e.g. vaporizing), sufficient ventilation of the chambers must be provided.

## Further products and services supplied by HS Anlagentechnik

- Curing chambers made of aluminium profile or specially galvanised steel profile
- Free-standing version with facade
- Air circulation systems
- Brett buffer shelves
- Mould storage racks
- Special racks
- Rails and sleepers
- Chamber insulation
- Roller shutters
- Complete assembly
- In the case of self-assembly, instruction and final inspection by our supervisor is possible
- Customer support, Advice & Planning from one hand

### HS Anlagentechnik CV

Veldkuilstraat 53  
6462 BB Kerkrade/Niederlande  
Tel.: 0031/45/5671190 · Fax: 0031/45/5671192

### Customer Service/Assembly

HS Anlagentechnik Ant GmbH & Co. KG  
Hegelstraße 6 · 57290 Neunkirchen/Deutschland  
Tel.: 0049/2735/781160 · Fax: 0049/2735/781162

info@hsanlagentechnik.com · www.hsanlagentechnik.com

